

Fan Installation Manual

Please take the time to read these instructions in full before commencing your installation.

Careful planning prior to starting work will guarantee the fastest and best results regarding the installation.



Working in the ceiling space can be a hazard, and all safety precautions should be used to ensure the safety of yourself and any others.



Installation Manual

125mm/150mm EC Mixed-Flow Fan for Bathroom Extraction

Thank you for your purchase of our company's product. It has been manufactured following current technical safety regulations and is in compliance with AS/NZ60335 standard.

Please read this instruction booklet carefully before installing or starting up the product.

It contains important information on personal and user safety measures to be followed while installing, using, and carrying out maintenance work on the equipment. Once the product has been installed, please hand this booklet to the end user.

Before installing the fan, it is important to understand the way this fan functions.

The fan is designed to be continuously powered.

When first powered on, the fan runs at low speed for 30s while initialising the sensors. After this the fan will increase to 40% speed and run for two minutes to purge the bathroom and learn the environment.

Over the next 10 minutes the fan will gradually slow down until it reaches the trickle speed (~10 l/s). The fan is now monitoring the bathroom for a change in the environment.

On detecting a change, the fan will respond and increase the speed accordingly. Once the environment has been restored, the fan will once again slow down to the trickle speed.

This model fan does not include the option of adding a remote switch input - refer to fan wiring on page 6 for details.

INSTALLATION OVERVIEW

Before commencing installation, select a suitable place for the fan to be installed in the ceiling cavity. The fan will be placed centrally within the ducted system, but should be no more than 2 metres away from the inlet grille. For maximum effectiveness of the fan, do not use more than 10m total length of ducting between the inlet and outlet.

It is recommended to suspend your fan from the ceiling framing with the chain provided in order to minimise the sound levels resonating through the ceiling framing. Do not screw the fan directly onto the timber frame!

Cut the hole for the inside grille and pull one end of the ducting through. Attach the spigot of the inside grille to the end of the flexible duct with the duct tape provided. Pull the ducting out to the fan, cut it to the desired length, and tape it onto the fan inlet.

Attach the remaining ducting to the fan outlet and feed the other end through the exterior grille hole. Ensure the ducting is long enough to tape onto the spigot of the outside grille. Cut off excess ducting and tape the end to the grille. Push the grille into place and fasten to the wall/soffit.

Please note:

The inlet of the fan unit is on the side of the fan blades, the side that is not obstructed by the fan frame. There are also arrows on the unit showing airflow direction.

Excessive ducting and sharp bends lower the fan's performance. Before cutting the ducting, ensure the duct is long enough, with gradual bends.

Important information for the safety of installers and user:

Installation must only be carried out by qualified persons. Make sure that the installation complies with the applicable building and electrical regulations.

This appliance is not intended for use by young children or infirm persons unless they have been adequately supervised by a responsible person to ensure that they can use the appliance safely. Young children should be supervised to ensure that they do not play with the appliance.

This apparatus must not be used in explosive or corrosive atmospheres. If a fan is going to be installed to extract air from premises where a boiler or other combustion apparatus are installed, make sure that the building has sufficient air intakes to assure adequate combustion. The extractor outlet must not be connected to a duct used to exhaust smoke or fumes from any appliance that uses gas or any other type of fuel.

TRANSPORT AND MANIPULATION

The packaging used for this apparatus has been designed to support normal transporting conditions. The apparatus must always be transported in its original packaging as not doing so could deform or damage the product. Do not place heavy weights on the packed product and avoid knocking or dropping it.

The product should be stored in a dry place in its original packaging, protected from dust and dirt until it is installed in its final location. Do not accept delivery if the apparatus is not in its original packaging or shows clear signs of having been manipulated in any way.

Check that the apparatus is in perfect condition while unpacking. *Any fault or damage caused in origin is covered by our company guarantee.* Please make sure that the apparatus coincides with the product you have ordered and that the details on the rating label fulfil your requirements.

ELECTRICAL CONNECTION

The extractor fan must be connected to a single-phase mains network, with the specific voltage and frequency according to the specifications on the fan rating label and in accordance with New Zealand electrical standards.

If the fan model you have purchased is fitted with a power plug then please note removing this plug will void the warranty of the fan.

In case of damage to the power plug, cord, or device itself, switch off the device and do not tamper with it. Damaged product must only be repaired or replaced exclusively by the manufacturer or by an appointed representative. Failure to comply with the above may endanger the safety of people and cause possible damage to the whole system.

SAFETY DURING INSTALLATION

Make sure there are no loose elements near the fan, as they could run the risk of being sucked up by it. If it is going to be installed in a duct, check that it is clean of any element that could be sucked up by the fan. When installing an apparatus, make sure that all the fittings are in place and that the structure which supports it is resistant enough to bear its weight at full functioning power.

Before installing the fan, make sure the mains supply is disconnected, even if the fan is switched off.

If the fan is installed in a duct, the duct must be used for the extraction system only.

STARTING UP THE FAN

Fans may have delayed startup, or may operate under the control of the inbuilt controlling electronics included with the fan. Always take extreme care as the fan may start unexpectedly. Always disconnect the fan from power during maintenance.

Before starting up the fan, ensure that:

- The fan is well secured and the electrical connections have been carried out correctly;
- Any electrical safety devices are correctly connected, adequately adjusted and ready for use;
- The wire and electrical connection inputs are correctly sealed and water-tight;
- If the fan has been mounted in a duct, the duct is clear of any loose material that could be sucked up by the fan.

When starting up the fan, ensure that:

- The propeller turns in the correct direction;
- There are no abnormal vibrations.

If the circuit protection device is tripping during operation, the fan must be quickly disconnected from the mains supply. The whole installation should be carefully checked before trying to start up the machine again.

MAINTENANCE AND REPAIR

Before servicing the fan, make sure it is disconnected from the mains supply - *even if it has previously been switched off*. Avoid the risk of anyone else plugging it in while you're working on it.

The fan must be regularly inspected. These inspections should consider the fan's working conditions, ensuring no dirt or dust builds up on the propeller, turbine, motor or grilles. This could be dangerous and perceptibly shorten the fan's lifespan. While cleaning, take extra care not to damage the propeller.

All maintenance work should be carried out in strict compliance with New Zealand safety regulations.

All our products contain repairable or replaceable parts. Repair or replacement of these parts should only be handled by the manufacturer. In the case of damage or malfunction of the fan, please contact the manufacturer or installer to arrange for repair. Please note that a small fee may apply for repair services not covered under warranty.

FAN MOUNTING



Suspend the fan with chain



EVOAQ extraction fan - outlet side

SYSTEM INSTALLATION

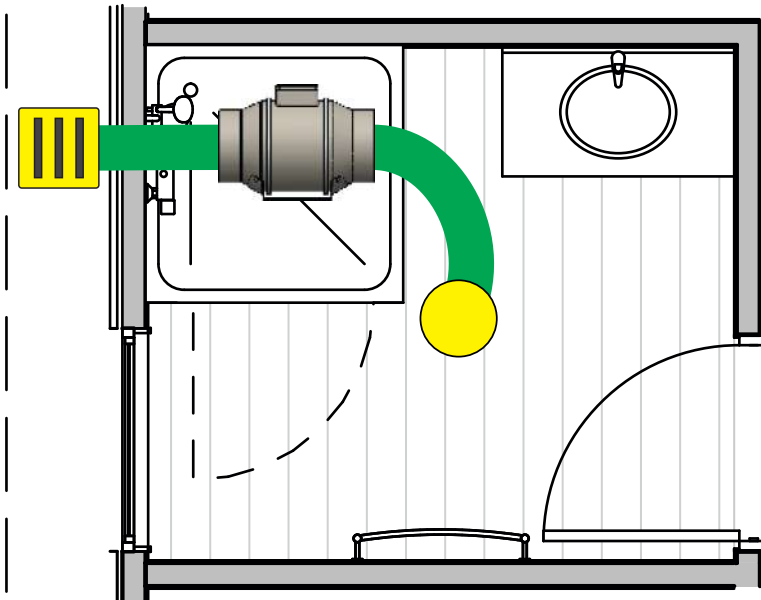
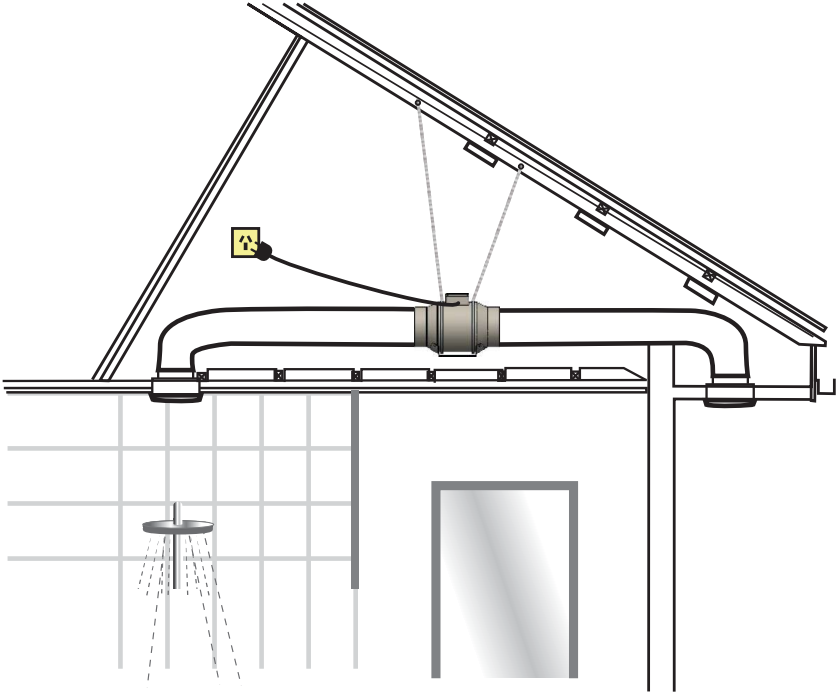

FAN WIRING

This fan includes a single power lead. Please refer to the images below to ensure the fan is wired correctly to prevent damaging the fan.

Power lead - Fan is fitted with plug; do not cut off plug unless necessary:

Blue = Neutral

Brown = Phase (Live)



Yellow/Green = Earth -> This product is double-insulated and not earthed, earth wire does not need to be connected

Please note that this fan model does not include wiring for an external switch input. If you would like to add an external switch input to the fan, please contact your installer or supplier to discuss available options.

EX-MFxxxSF Mixed Flow Fan Specifications

Fan Part Number	EX-MF125SF	EX-MF150SF
Fan Spigot Size	125mm	150mm
Voltage (V/Hz)	230 / 50	230 / 50
Power (W)	1 - 17	3 - 70
Air Flow (L/s)	12 ~ 80	17 ~ 180
Static Pressure (Pa)	159	503
Noise Level (dB)	28	31
Speed (RPM)	180 ~ 2250	500 ~ 3000
Specific Fan Power (SFP)	0.175 W/Ls ⁻¹	0.356 W/Ls ⁻¹

For all our manuals, fan specifications, system details and more information visit www.evoaq.co.nz/downloads



For further information, please contact EvolutionFX NZ Limited

email: info@evolutionfx.co.nz

phone: +64 9 558 5590

Extraction Inlet

Place extraction inlet within 1-2 metres from the shower or bath - the inlet should not be placed directly above the shower unless absolutely necessary.

Remove the black connector from the white grille insert for easier taping during install.

Recommended Holesaw Size:

- 127mm (125mm grille)
- 152mm (150mm grille)



Flexible Ducting

Avoid any sharp bends or corners when placing ducting - choose the shortest route.

Use plenty of tape to secure ducting onto fan, extraction inlet and outlet grille.

Recommended Ducting Length - 10m total max.

- Up to 2m between inlet and fan
- Up to 4m between fan and outlet grille

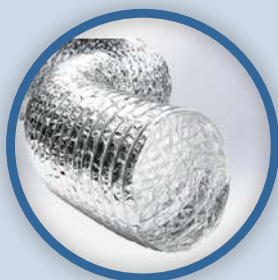

EVOAQ Extraction Fan

Use chain to suspend fan from rafters - do not screw the fan directly to the timber!

Keep ducting straight and level with the fan.

Plug fan into power point using the power cord provided. If no powerpoint is available, one should be installed by a registered electrician.



Do not install the fan electronics upside down as this may damage the fan

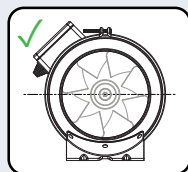
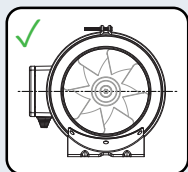
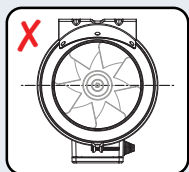

Automatic Bathroom Extraction Fans

EVOAQ Bathroom Extraction fans work by running at a low trickle speed and constantly monitoring the moisture levels within the bathroom environment.

In-built controls and sensors in the fan control the fan speed to extract any excess moisture and protect your bathroom.

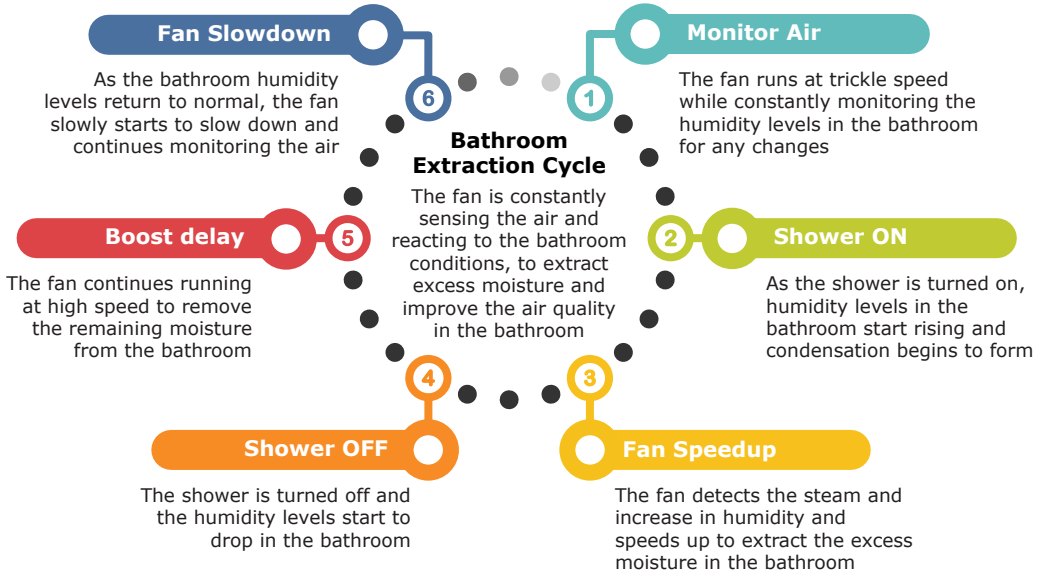

Start-up Boost

30 seconds after being plugged in, the fan enters a 2-minute startup boost on high speed to ensure bad or stale air is removed from the bathroom, before the fan slowly slows down and begins its Bathroom Extraction Cycle

Boost Switch - optional

A remote low-voltage switch may be wired into selected fan models as a 'boost switch'. If the switch is on, the fan runs at high speed. When the switch is turned off again, the fan slowly slows down and resumes its Bathroom Extraction Cycle



Like **EVOAQ**
on Facebook

**Fully Automatic
Bathroom Extraction.
Just Plug and Play.**

Follow **evoaqnz**
on Instagram

